

RJW7101/LT, RJW7102A/LT Explosion-protected Portable Searchlight



- Type of protection: flameproof enclosure
- LED light source providing service life up to 100000 hours
- Two lighting modes: working light and strong light
- Indication of available operating time and low power indicator
- Compact and robust design



COMPONENTS

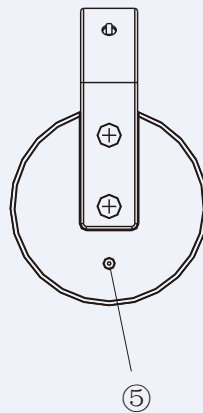
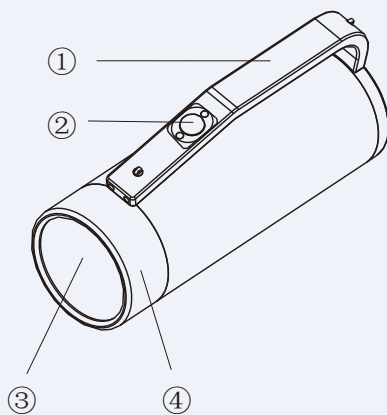

1. Handle
2. Switch
3. Light source
4. Light head
5. Charging port

APPLICATION

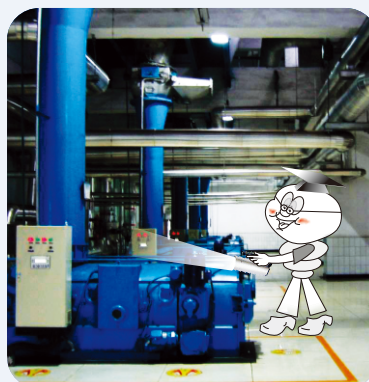

TECHNICAL SPECIFICATION

CERTIFICATION & APPROVALS

CNEX  Ex dia IIC T6 Gb NLE 08400

MATERIALS

Enclosure Aluminous alloy
Transparent cover Tempered glass

ELECTRICAL PARAMETER

Input 100V~240V AC 50Hz~60Hz
Output 14.8 V DC
Ambient temperature -20 °C to +55 °C
Degree of protection IP68

BATTERY

Type Lithium battery
Capacity 2 Ah
Battery life approx. 1000 cycles
Charging time 5 h
Duration-RJW7102/LT ≥ 10 h (working light)
 ≥ 4.5 h (strong light)
Duration-RJW7102A/LT ≥ 13 h (working light)
 ≥ 7 h (strong light)

LAMP

Type LED
Current-RJW7102/LT 250 mA (working light)
 500 mA (strong light)
Current-RJW7102A/LT 200 mA (working light)
 400 mA (strong light)
Watts 6 W
Lamp life ≥ 100000 h

Dimensions in mm

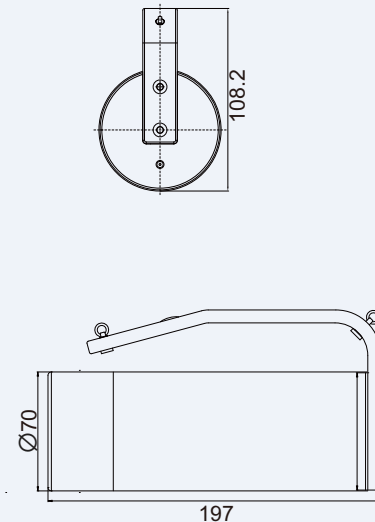

CONFORMITY TO STANDARDS

IEC60079 / IEC60598

SELECTION TABLE

Designation	Description	Weight
Model	RJW7102/LT	0.95 kg
	RJW7102A/LT	